

marantz®

**Model 2252
Stereophonic
Receiver**

MARANTZ CO., INC. 20525 NORDHOFF STREET, CHATSWORTH, CALIFORNIA 91311
A WHOLLY-OWNED SUBSIDIARY OF SUPERSCOPE INC., CHATSWORTH, CALIFORNIA 91311

FOREWORD

For optimum performance and enjoyment from your Model 2252 Stereo Receiver, please study these instructions carefully. Installation and operation are not complicated, but its flexibility and features deserve your becoming familiar with its controls and connections.

This manual is divided into two parts. The first covers installation and operation in simple, non-technical language. The second describes the 2252 in more detail with technical specifications and functional explanations.

For quick identification of the controls and connections, references to them are printed in **BOLD-FACE TYPE**, exactly as they appear on the front and rear panels of your Receiver.

AC Line Operation

WARNING: TO PREVENT FIRE OR SHOCK HAZARD, DO NOT EXPOSE THIS APPLIANCE TO RAIN OR MOISTURE.

GENERAL DESCRIPTION

The Marantz Model 2252 is an all solid state receiver incorporating the innovative design and unparalleled technology that have made Marantz famous in the audio component industry.

The Model 2252 features a sensitive stereo FM tuner, a highly selective AM tuner, and a low distortion preamplifier and amplifier on a single chassis. The FM tuner features a front end which employs a dual gate MOSFET and FM IF unit, a phase locked loop multiplex decoder and an AM tuner, all of which utilize IC's throughout. The amplifier sections permit the connection of two stereo pairs of loud-speakers, a turntable or record changer, two tape recorders, stereo headphones, and an auxiliary source such as an additional tuner or a TV sound source.

AFTER UNPACKING

It is advisable to retain all original packing material to prevent damage should you wish to transport or ship the Model 2252 (refer to page 14 for repacking and shipping instructions). Be careful that you do not inadvertently throw away or lose the parts packed with the unit.

Please inspect your Model 2252 carefully for any signs of shipping damage. Our very strict quality control and professional pride ensure that each Model 2252 left the factory in perfect condition. If the unit is damaged or fails to operate, immediately notify your dealer. If the unit was shipped to you directly, notify the transportation company without delay. Only you, the consignee, may institute a claim against the carrier for shipping damage. Save the carton and all packing material as evidence of damage for their inspection. Should assistance be required, the Marantz Company will cooperate fully in assisting your claim.

Please fill out and mail the Warranty Registration Card within ten days of purchase. The card will remain on file at the Marantz Company for the duration of the warranty period. We also strongly advise that you retain your sales receipt to provide proof of purchase in the event that warranty service is sought.



Figure 1. Rear Panel Connection Facilities

PREPARATION FOR USE

REAR PANEL CONNECTIONS

Figure 1 shows the location of input and output jacks on the rear panel. These jacks are for "permanent" connections. Front panel jacks and their use will be discussed later.

All connections to the rear panel should be made with the power to the entire system turned off. The rear panel signal connections are arranged in stereo pairs. All signal connections to the Model 2252, with the exception of the FM antenna and loudspeakers, should be made with shielded audio cables. To avoid confusion, connect one cable at a time between the 2252 and the other components of your system. This is the safest way to avoid cross-connecting channels or confusing signal sources with destinations.

PHONO INPUTS

The phono jacks are intended for use with magnetic phono cartridges and have a 47,000 ohm input impedance.

If a hum is heard when playing records, this is an indication that the record player or its connections are incorrectly grounded. Connect a separate ground wire from the turntable or record changer from to the **CHASSIS GROUND** binding post of the Model 2252. If this is ineffective, try reversing the polarity of the turntable's power plug.

If hum persists, consult the instruction booklets for the turntable and/or phono cartridge.

TAPE JACKS

TAPE 1 IN

The pair of TAPE 1 IN jacks serve two purposes:

1. By depressing the **TAPE 1 MONITOR** push-switch, signals can be played from a tape recorder set for playback mode of operation. This permits playing the tape source stereophonically or monophonically as indicated by the position of the **MONO** pushswitch.
2. While your tape recorder is recording, you can monitor the resulting tape quality by depressing the **TAPE 1 MONITOR** pushswitch. This requires that your recorder be equipped with separate record and playback heads and separate record and playback electronics.

TAPE 2 IN

The signals from your tape recorder connected to the **TAPE 2 IN** jacks can be played back when the **SELECTOR** switch is placed in the **TAPE 2** position and the **TAPE 1 MONITOR** switch is released. In addition, these jacks allow tape copying from **TAPE 2** to **TAPE 1**. The resulting recording can be monitored by depressing the **TAPE 1 MONITOR** pushswitch.

TAPE 1 & 2 OUT

Connecting these jacks to the line inputs of a tape recorder permits recording from the program source indicated by the **SELECTOR** switch. The

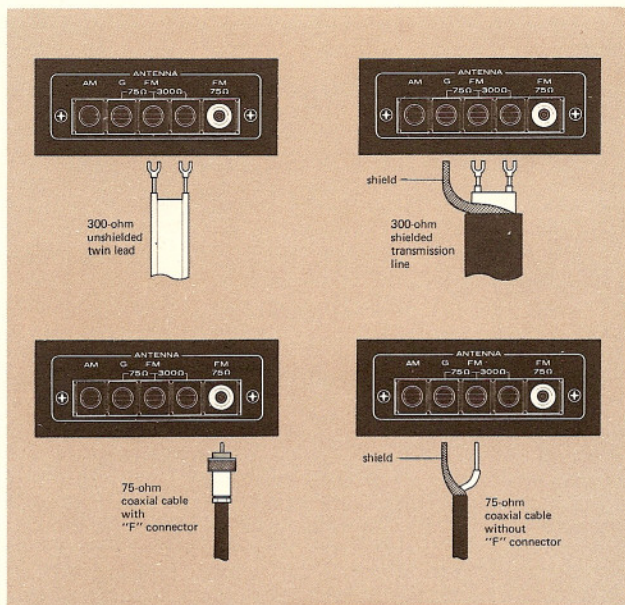

Figure 2. AM/FM Antenna Connection

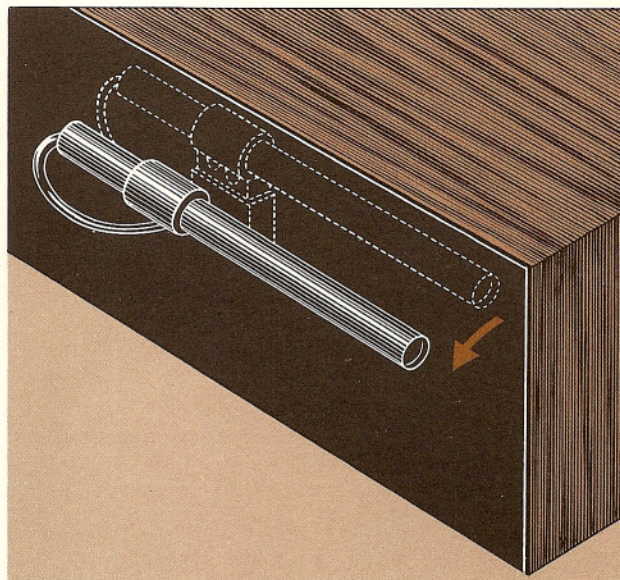

Figure 3. AM Ferrite-rod Antenna

signals available at this pair of jacks are not affected by the **BALANCE, VOLUME, TREBLE, BASS, HI FILTER, LOUDNESS,** and **MONO** pushswitches on the front panel.

AUX INPUTS

The **AUX INPUT** jacks are for miscellaneous high level signal sources such as additional tuners and/or receivers, tape players, phonographs that provide RIAA equalized high level output, TV sound outputs and other external components.

FM ANTENNA

The best FM reception is obtained with a Log-Periodic type antenna mounted on a good quality rotor system. For fringe areas, Marantz recommends a Log-Periodic antenna with six or more elements designed expressly for FM reception. To minimize local noise and multipath picked up by the lead-in wires, use a balanced and shielded 300 ohm cable or a coaxial 75 ohm cable with a 300 to 75 ohm matching transformer at the antenna. Unshielded lead-in acts as an omnidirectional antenna, and can cancel the directional benefits of your antenna. Low-loss 300 ohm shielded cable consists of two inner conductors plus an outer shield and insulating jacket. This type of shielded cable effectively prevents the lead-in from contributing multipath distortion.

For rural areas, it is recommended that a local dealer be consulted about antenna installation and lightning arrestor protection. Master antenna systems are not recommended for use with your

Model 2252; such systems are usually designed expressly for television reception and frequently suppress FM signals before distribution. In addition, master antenna systems often severely reduce the quality of the FM signal. Where outdoor antennas are prohibited or inconvenient, place the antenna in vacant attic space or use a simple 300 ohm TV "rabbit ear" antenna or the ribbon-type folded dipole antenna supplied with the Model 2252. Both are practical and will give satisfactory results in primary signal areas.

Figure 2 shows connection methods for various antennas. If 75-ohm cable is desired, we recommend using the type with an "F"-type connector terminal attached to the cable. This is the easiest type of cable to connect and disconnect.

AM ANTENNA

Your Tuner is equipped with an AM ferrite-rod antenna. **BEFORE USING THE MODEL 2252, SWING THE ANTENNA OUT AS SHOWN IN FIGURE 3.**

The ferrite-rod antenna will give you satisfactory results in primary signal areas. However, an outdoor antenna will provide better reception in weaker signal areas. Three single wires are required to make an AM outdoor antenna. First, connect one end of a single wire to the **AM ANTENNA** terminal on the rear panel, and the other end to a very high horizontal antenna wire of 25 to 75 feet in length suspended between insulators in an outdoor location (the higher the better). Next, connect the third single wire between the "G" terminal of your Model 2252 and an authenticated earth ground (such as a metal water pipe).

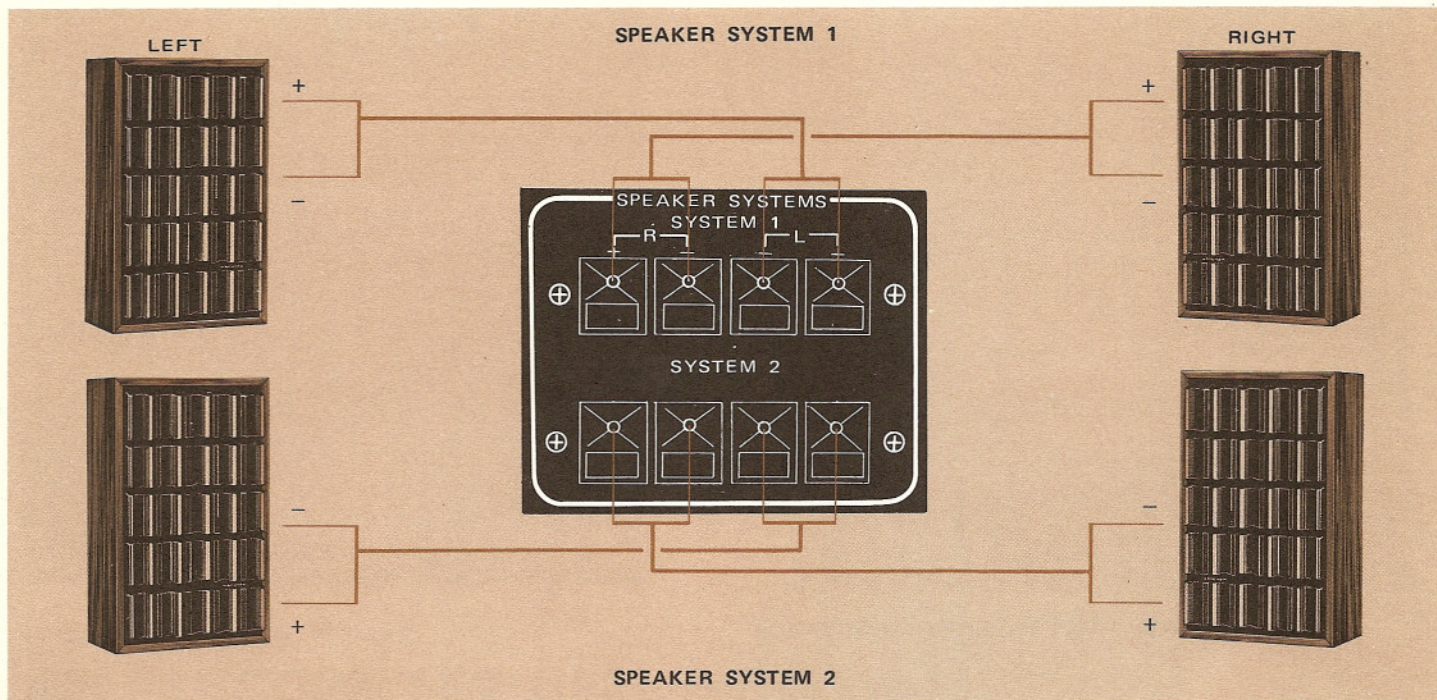

Figure 4. Loudspeaker System Connections

FM QUADRADIAL OUTPUT JACK

In anticipation of future four channel quadrasonic broadcasting, your Model 2252 is equipped with an **FM QUADRADIAL OUTPUT** jack. The signal available at this jack is the unequalized buffered output of the FM discriminator. Its level, frequency response characteristics, and output impedance are ideal to drive a four channel adaptor. This jack can also be used as a simple "white noise" generator for checking the response characteristics of loudspeakers or amplifiers. For this application, connect the **FM QUADRADIAL OUTPUT** jack to the **TAPE 1** input jack, press the **TAPE 1 MONITOR** switch, place the Model 2252 in FM mode with the muting off and tune between FM stations to receive interstation noise.

PRE OUT AND MAIN IN JACKS

The **PRE OUT** jacks deliver the output of the Model 2252 preamplifier circuits to the rear panel. The **MAIN IN** jacks are the input terminals of the power amplifier section of the Model 2252. The **PRE OUT** and **MAIN IN** jacks are bridged internally by special contacts within the jack assembly. When you wish to use such equipment as a graphic equalizer, compressor/limiter, or expander, you may connect these instruments to your Model 2252 with appropriate lengths of shielded audio cables. When the external equipment is connected, the insertion of its **RCA** phono plug in to the **MAIN IN** jacks automatical-

ly breaks the internal connections to prevent the external equipment from being bypassed.

SPEAKER SYSTEMS

The **SPEAKER SYSTEMS** terminals on the rear panel can accommodate two stereo pairs of loudspeakers. Connect the main pair to the **SYSTEM 1** terminals. The **SYSTEM 2** terminals are for a second stereo pair of loudspeakers (see Figure 4). Selection of loudspeaker systems is made with the **SYSTEM 1-SPKR-SYSTEM 2** pushswitches on the front panel.

To connect the speakers to the 2252, use ordinary #18 gauge two conductor lamp cord. For distances longer than 30 feet, use #16 gauge wire or heavier.

SPEAKER PHASING

To assure the best stereo separation and frequency response, the speakers must be properly phased. The positive terminal on each speaker should be connected to its respective (+) terminal on the Model 2252, and the negative or "common" terminal should be connected to its respective (-) terminal. To verify that a pair of speakers are correctly phased, perform the following test:

1. Complete the necessary signal connections so that program material may be played through the speakers.

2. Place the speakers in the center of the room.
3. Depress the **MONO** pushswitch and play a record (or radio or tape) with strong bass tones at a low volume level. Center the **BALANCE** control.
4. Position the speakers about six inches apart, face-to-face. Listen, particularly to the apparent loudness of the bass tones.
5. Next, turn off all power, but do not disturb the **VOLUME** or **BALANCE** settings. Reverse the connections on the right speaker only. Turn on the power and listen again. If the bass tones now seem louder than in (3), you have corrected the phasing between the speakers. If the bass notes now sound softer, turn off the power and reconnect the speakers as they had been originally.
6. If an additional pair of speakers is used along with the main speaker system, check phasing between the remote speakers and the main speakers. Use the **BALANCE** control to play only two speakers at once, and invert the wiring on the remote speakers as necessary. Do not change the connections on the main speaker system.
7. Once having phased all speakers, you need not repeat this procedure in the future if you now mark the speaker connections and/or cables. Any method of coding is satisfactory, provided it enables you, in the future, to duplicate your now-correct hookup between speakers and amplifier.

Use caution when connecting your Model 2252 to a loudspeaker with built-in power supply such as an electrostatic loudspeaker. The "common" connection terminal of such a speaker may be capacitively coupled to ground through its own power supply. To protect the Model 2252 from distortion and possible overload, make sure the (—) terminals of the Model 2252 are connected to the "common" terminals of such a loudspeaker system.

CAUTION: NEVER DIRECTLY CONNECT THE LOUDSPEAKER TERMINALS OF ONE CHANNEL IN PARALLEL WITH THOSE OF ANY OTHER. ANY RESULTING DAMAGE IS NOT COVERED UNDER WARRANTY.

NOTE: Do not use 4 ohm speakers if main and remote speakers are to be used simultaneously. Use 8 or 16 ohm speakers only.

CONNECTION TO AC OUTLET

With the front panel **POWER** pushswitch "OUT", plug the line cord into an electrical outlet supplying the proper voltage.

CAUTION: DO NOT PLUG YOUR MODEL 2252 INTO A DC OUTLET, AS SERIOUS DAMAGE WILL OCCUR.

CONVENIENCE OUTLETS

One **UNSWITCHED** and one **SWITCHED AC OUTLET** are provided on the rear panel for powering associated components of your system (tape recorder, record player, etc.).

AC PROTECTOR FUSE

This feature automatically disconnects AC power in the event of a power source or circuit overload. If the **POWER** pushswitch is activated and the front panel fails to illuminate and no sound is heard through the speakers, turn off the power and unscrew the fuse holder on the rear panel and visually inspect the fuse to see if the internal conducting filament has opened. If so, replace the fuse with one having the same specifications. See "Fuse Replacement", page 11.

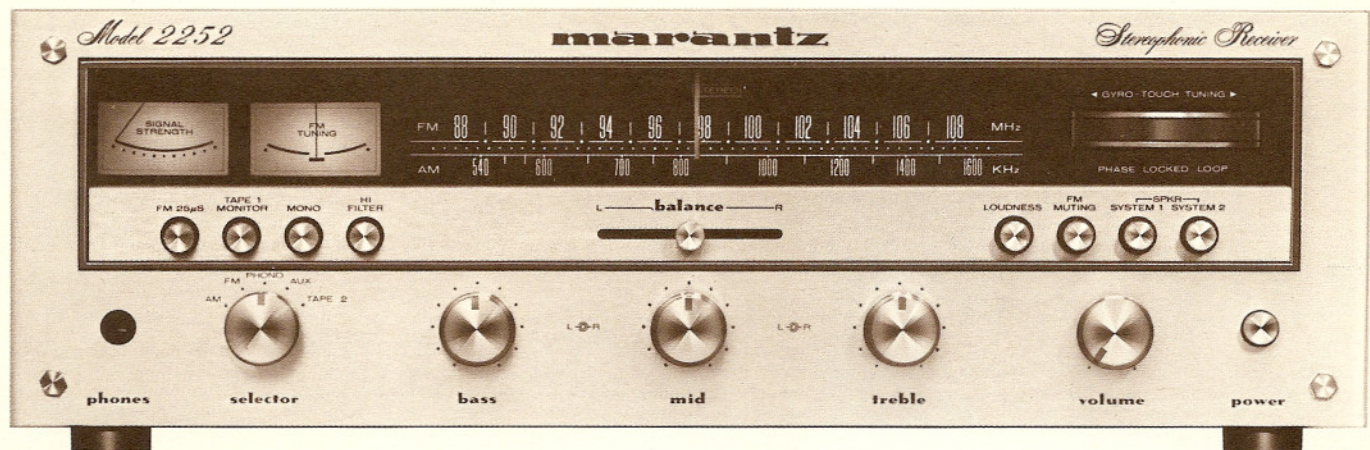

Figure 5. Front Panel Controls and Jack

SIMPLIFIED OPERATING PROCEDURES

When operating the Model 2252 Stereo Receiver for the first time, follow these simple directions. Later, full advantage can be taken of its versatility with the remaining controls and pushswitches.

- Step 1. Connect the FM antenna to the appropriate terminals on the rear panel.
- Step 2. Connect the speakers to the **SYSTEM 1** speaker terminals.
- Step 3. Place all pushswitches in the "out" position.
- Step 4. Turn the **VOLUME** control all the way to the left (counterclockwise) and set the balance control in center position.
- Step 5. Rotate **TREBLE**, **MID** and **BASS** controls to the 12 o'clock position (each pair of pointers to dot).
- Step 6. Depress the **SYSTEM 1** speaker push-switch.
- Step 7. Apply system power by depressing the **POWER** switch.
- Step 8. Select the desired program source by setting the **SELECTOR** switch to the appropriate position. If **FM** or **AM** is selected, rotate the Gyro-Touch **TUNING** knob until the desired station is tuned. Adjust the volume control to a comfortable listening level.

MAIN CONTROLS AND SWITCHES

POWER SWITCH

The **POWER** switch, when depressed, supplies AC power to the Model 2252 and to the **SWITCHED** outlet on its rear panel.

SELECTOR SWITCH

The **SELECTOR** switch selects the program source for listening or recording. If a tape recorder's playback output has been connected to the **TAPE 2 IN** jacks on the rear panel, you can select tape listening by rotating the **SELECTOR SWITCH** to the **TAPE 2** position.

VOLUME CONTROL

The **VOLUME** control adjusts the level of both output channels simultaneously while maintaining stereo balance at all normal settings. It does not effect the recording outputs.

BALANCE CONTROL

This control alters the level of either output channel in situations where it is necessary to correct unbalanced programs sometimes encountered in older stereo recordings or in stereo broadcasts. As it is moved from its center position, it decreases the level in one output channel while maintaining the level in the other channel.

BASS, MID AND TREBEL CONTROLS

These controls are used to adjust the tonal balance of program material to suit individual listening preference.

TUNING METER

The Model 2252 is equipped with two meters, a **SIGNAL STRENGTH** Meter and a **TUNING** Meter.

1. The **SIGNAL STRENGTH** Meter indicates the signal strength of any AM or FM broadcast.
2. The **TUNING** Meter operates on FM only and indicates correct center tuning of the station.

GYRO-TOUCH TUNING CONTROL

AM

Switch the **SELECTOR** to **AM** and tune to the desired station. Then rotate the **GYRO-TOUCH TUNING** knob slightly back and forth until the maximum reading is obtained on the **SIGNAL STRENGTH** Meter. The **TUNING** Meter is not used for AM.

FM

Switch the **SELECTOR** to **FM** and tune to the desired station. Then slowly rotate the **GYRO-TOUCH TUNING** knob back and forth until maximum reading is obtained on the **SIGNAL STRENGTH** Meter and the **TUNING** Meter points to the center scale position. The multiplex section of the Model 2252 is equipped with electronically triggered circuits which mute interstation noise and automatically switch to the proper mode of operation for stereo and monophonic FM broadcasts. In addition, the **STEREO** indicator light automatically indicates a stereo broadcast.

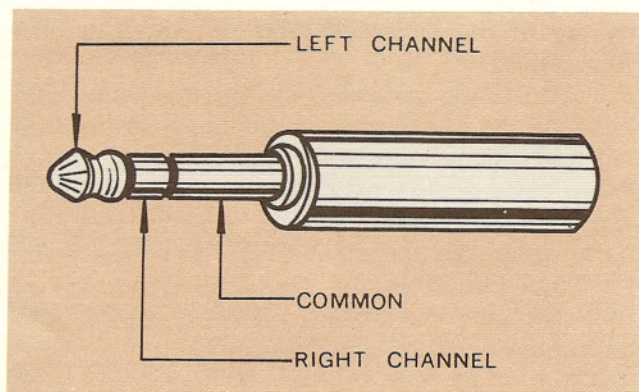

Figure 6. Stereophone Plug

FM-25 μ S SWITCH

To listen to a Dolbyized FM broadcast, connect a Dolby noise reduction adaptor between the **TAPE 1 OUT** and **IN** jacks on the rear panel of the Model 2252. Depress the **FM-25 μ S** pushswitch, and depress the **TAPE 1 MONITOR** switch. With the **FM-25 μ S** switch in, the audio output signals are preset internally to standard Dolby level, and the de-emphasis time constant applied to the signals is also switched to 25 μ sec automatically.

SYSTEM 1-SPKR-SYSTEM 2 SWITCHES

These switches select the loudspeaker terminals to which audio power is fed. Either the **SYSTEM 1** or the **SYSTEM 2** stereo pair of loudspeakers may be operated individually, or simultaneously if both switches are depressed. When the two **SYSTEM 1-SPKR-SYSTEM 2** switches are in the normal "out" position, all loudspeaker terminals are internally disconnected from the power amplifier section. The signal at the headphones jack is not affected by the **SYSTEM 1-SPKR-SYSTEM 2** switches. The "out" position allows "private listening" when stereo headphones are used.

NOTE: Volume level should be reduced to minimum when switching speakers.

PHONES JACK

This jack accepts headphones utilizing a standard three conductor phone plug (see Figure 6). It is internally connected to the power amplifier section through isolation resistors to provide adequate sound level with popular low impedance headphones as well as with high impedance units. Two or more sets of headphones may be used with the aid of "Y" connectors. However, output level will drop as additional headphones are added. The headphone jack output is not affected by the **SYSTEM 1-SPKR-SYSTEM 2** switches.

FM MUTING SWITCH

When tuning to FM broadcasts with the **MUTING** switch in its "in" position, the muting circuit will eliminate interstation noise. To prevent muting very weak stations along with the noise, the muting action may be switched off by releasing the **MUTING** pushswitch.

LOUDNESS SWITCH

The **LOUDNESS** switch compensates for human hearing characteristics by boosting the bass and treble response at low volume levels to achieve a more pleasing tonal balance.

HI FILTER SWITCH

This switch can be used to reduce high frequency noise such as that associated with the playing of poorly recorded tapes or worn disc recordings. When the AM tuner is being used, this switch will help to suppress considerably the high pitched "whistle" caused by adjacent AM channel interference. This filter will also, along with high frequency noise, slightly attenuate high frequency program material, and should therefore be used judiciously.

MONO SWITCH

When a marginal stereo signal is received, random noise and phase modulation may cause the tuner's multiplex circuitry to trigger the **STEREO** mode intermittently. In this case, it is sometimes desirable to cancel the multiplex operation entirely in favor of obtaining a more listenable signal. The **MONO** switch performs this function and converts all output signals to the **MONOPHONIC** mode.

While playing a single channel source such as TV or AM, depress the **MONO** pushswitch to hear the source through both speakers. When playing a monophone phonograph record, use this pushswitch to suppress rumble, record surface noise, and pinch effect distortion.

TAPE 1 MONITOR SWITCH

When this pushswitch is "out", the program being recorded and heard is determined by the setting of the **SELECTOR** switch. With the **TAPE 1 MONITOR** pushswitch "in", the amplifier input connections are switched to the output of the tape recorder without affecting the signal presented to the tape recorder's input, thus allowing you to listen to the signal being recorded before and after recording. This switch is also known as the **TAPE-SOURCE** switch.

TAPE RECORDING AND DUBBING

RECORDING

The program source selected by the **SELECTOR** switch may be recorded on to either tape recorder. When the **SELECTOR** is set to **TAPE 2**, however, the **TAPE 2 OUT JACKS** are muted to prevent feedback oscillations that would occur if tape recorder 2 were inadvertently placed in the record mode.

DUBBING

A tape played on tape recorder 2 may be copied on to tape recorder 1. Set the **SELECTOR** switch to **TAPE 2**. To monitor tape 1 as it is being recorded, depress the **TAPE 1 MONITOR** switch. To monitor the source (which is, in this case, tape 2), release **TAPE 1 MONITOR** switch. Either tape or source can be monitored without disturbing the actual recording process.

RECORDING DOLBYIZED FM PROGRAMS

Dolbyized FM broadcasts contain Dolbyized audio information to which a special pre-emphasis is applied for the purpose of improving the noise reduction process. To make a Dolbyized tape recording of such broadcast, depress the **FM-25 μ S** switch to properly de-emphasize the signal, but bypass the noise reduction adaptor to record the Dolbyized audio directly onto the tape. This can be done by switching the Noise Reduction switch to "OFF" if the Dolby adaptor is so equipped, or by connecting the **TAPE OUT** jacks of the 2252 directly to the **LINE IN** jacks of the tape deck.

The inputs to the tape recorder in this application must be properly calibrated beforehand according to the procedure detailed in the Dolby unit's instruction booklet. To achieve proper calibration, it is necessary that the record level control on the Dolby unit be adjusted to the proper Dolby level by use of the reference tone transmitted by the FM station.

For monitoring purposes, connect the Dolby unit between the line outputs of the tape recorder and the **TAPE IN** jacks on the 2252.

When using a tape recorder containing a built-in FM-25 μ S de-emphasis circuit, a better signal-to-noise ratio can be achieved by using only the FM-25 μ S circuit in the Model 2252 instead of the facilities in the tape recorder. Do not use both de-emphasis circuits simultaneously.

TECHNICAL DESCRIPTION

GENERAL

Figure 7 is a block diagram of the Model 2252 Receiver showing the main functional elements and input and output signal routing. For clarity, only the left audio channel is shown; the right audio channel is identical. The **MONO** switch is common to both channels. All audio controls are ganged to their counterparts in the right channel.

FM FRONT END

FM antenna signals are applied through the antenna coil to the dual gate MOSFET RF amplifier. The signals from the RF amplifier are fed through the tuned RF tank circuit to the mixer stage where the carrier frequency is converted to the 10.7 MHz intermediate frequency. It is then fed to the input of the IF amplifier.

Careful attention to the thermal and electrical characteristics of the local oscillator has minimized drift, thus eliminating the necessity for AFC.

FM IF AMPLIFIER

The FM IF amplifier system is composed of one IC expressly developed for FM IF use, plus one transistor and three dual-element ceramic filters. The IC includes a complete IF amplifier, limiter stages, FM discriminator, and a 6-stage double ended type differential amplifier providing excellent AM rejection.

The FM discriminator stage is composed of a double balanced type quadrature detector circuit. The signal from the front end is fed to the IC through the 3 ceramic filters and the one transistor amplifier.

The characteristics of these filters are ideal in that the 200 kHz passband is phase linear, with sharp cutoff slopes. Its exceptional phase linearity assures the elimination of a major source of high frequency distortion and a loss of stereo separation. The sharp cutoff slopes provide outstanding selectivity, permitting reception of closely spaced stations.

FM STEREO DEMODULATOR

The stereo composite signal obtained from the quadrature detector is fed to the MPX IC. The L and R signal outputs from the MPX IC are applied through the low-pass filter and the de-emphasis circuit to the one (per channel) transistor ampli-

fier. The output (about 1100 mV) obtained from this amplifier is fed to the L and R output terminals at the rear panel through the function switch.

This stereo demodulating IC employs a PLL (Phase Locked Loop) technique, whereby the phase of the 38 kHz switching carrier signal in the decoder is constantly interlocked with the phase of the 19 kHz input pilot signal. Phase shift of the switching carrier (38 kHz) is thereby eliminated and deterioration of separation and distortion does not occur.

19 kHz and 38 kHz muting circuits are not employed so that stability is greatly improved. Muting distortion, as a result of element aging or adjacent temperature changes, is consequently eliminated.

The stereo demodulating 38 kHz carrier switching signal is very clean with no even harmonic content. SCA rejection of approximately 80 dB is obtained since resonant beats are not generated between the secondary harmonic (76 kHz) of the 38 kHz carrier switching signal and the SCA signal (67 ± 7 kHz).

MUTING CIRCUIT

If there are no signals present, any FM tuner will generate some noise. The muting circuit eliminates this noise. In addition, spurious noise that is generated while tuning is also removed. The muting circuit in the Model 2252 is integrated into the IF stage. The circuit is also designed to minimize popping noises which tend to be generated when muting is switched in and out.

AM TUNER

The AM tuner section of the Model 2252 is composed of an IC (incorporating an RF amplifier, local oscillator, mixer, IF amplifier, and detector) and a one transistor audio amplifier which amplifies the detected audio signals. A two section variable capacitor is used to tune the antenna and mixer stages. The ceramic filters utilized in the AM IF amplifier are designed for high selectivity and wide bandwidth for interference-free high quality AM reception. Following the AM IF amplifier, the AM detector recovers the audio modulation and presents this signal to the audio amplifying stage and the mode selector switch. The AM tuner and IF amplifier are subjected to the action of an effective automatic gain control circuit which maintains a constant volume level for all stations in the AM band.

SELECTOR SWITCH

The Model 2252 has the capability to operate from a variety of program sources, such as AM or

FM broadcasts, turntable (**PHONO**), tape player, or any other source capable of providing 200 mV output level (**AUX**). The **SELECTOR** switch connects the inputs of the **TONE** control amplifier to the desired source.

TAPE 1 MONITOR SWITCH

The **TAPE 1 MONITOR** switch selects between source and **TAPE 1 INPUT** jacks. When the **TAPE 1 MONITOR** switch is in its normal "out" position, the preamplifier receives its input from the **SELECTOR** switch. When the **TAPE 1 MONITOR** switch is depressed, the preamplifier receives its input from the **TAPE 1 IN** jacks.

PHONE EQ AMPLIFIER

Phono signals of up to 100 mV can be handled without overloading. The equalization network provides precise equalization to the RIAA standard and sets the voltage gain of the phono preamplifier to 40 dB (at 1 kHz).

MONO FUNCTIONS

When the **MONO** pushswitch is in the "in" position, the two channels are connected together through mixing resistors. In addition, the left and right channel tape input signals are connected together through the same resistor network. This facility allows all inputs to be converted to the monophonic mode.

CONTROL CIRCUITS

The control circuits portion of the Model 2252 consists of the **BALANCE**, **VOLUME**, **BASS**, **MID**, **TREBLE**, and **HI FILTER**, controls. All controls affect the left and right channels simultaneously. However, the **BASS**, **MID** and **TREBLE** controls have clutched sections which allow individual adjustment of tonal balance for each channel. With the controls set for flat response and volume control at maximum, the overall voltage gain from any high-level input to the loudspeaker terminals is approximately 41 dB.

BALANCE CONTROL

The **BALANCE** control is a full range control which permits attenuation of each channel to cutoff. The change of attenuation in each channel as the control is moved from center has been designed to maintain total apparent loudness from both channels. This feature makes it a true stereo balance control.

VOLUME CONTROL

The **VOLUME** control attenuates both channels simultaneously and maintains tracking to within 3 dB at any point of attenuation to -60 dB from maximum. Since the control is situated at the input of the tone amplifier, there is no possibility of overloading the amplifier stages under maximum rated output conditions. Thus, distortion is kept to a minimum. After attenuation by the **BALANCE** and **VOLUME** controls, the signal is applied to the tone control amplifier.

TONE CONTROL AMPLIFIER

The **TONE CONTROL AMPLIFIER**'s circuitry uses a continuously variable negative feedback type configuration for lowest distortion. The signal from the **TONE CONTROL AMPLIFIER** feeds the **HI** filter circuit when the **HI FILTER** is activated.

AMPLIFIER

The amplifier section of the Model 2252 is a direct coupled, full complimentary circuit. It utilizes current limiting and thermal compensation circuits to provide safe, highly stable operating conditions. The silicone output devices used in the power amplifier section provide a large collector dissipation margin.

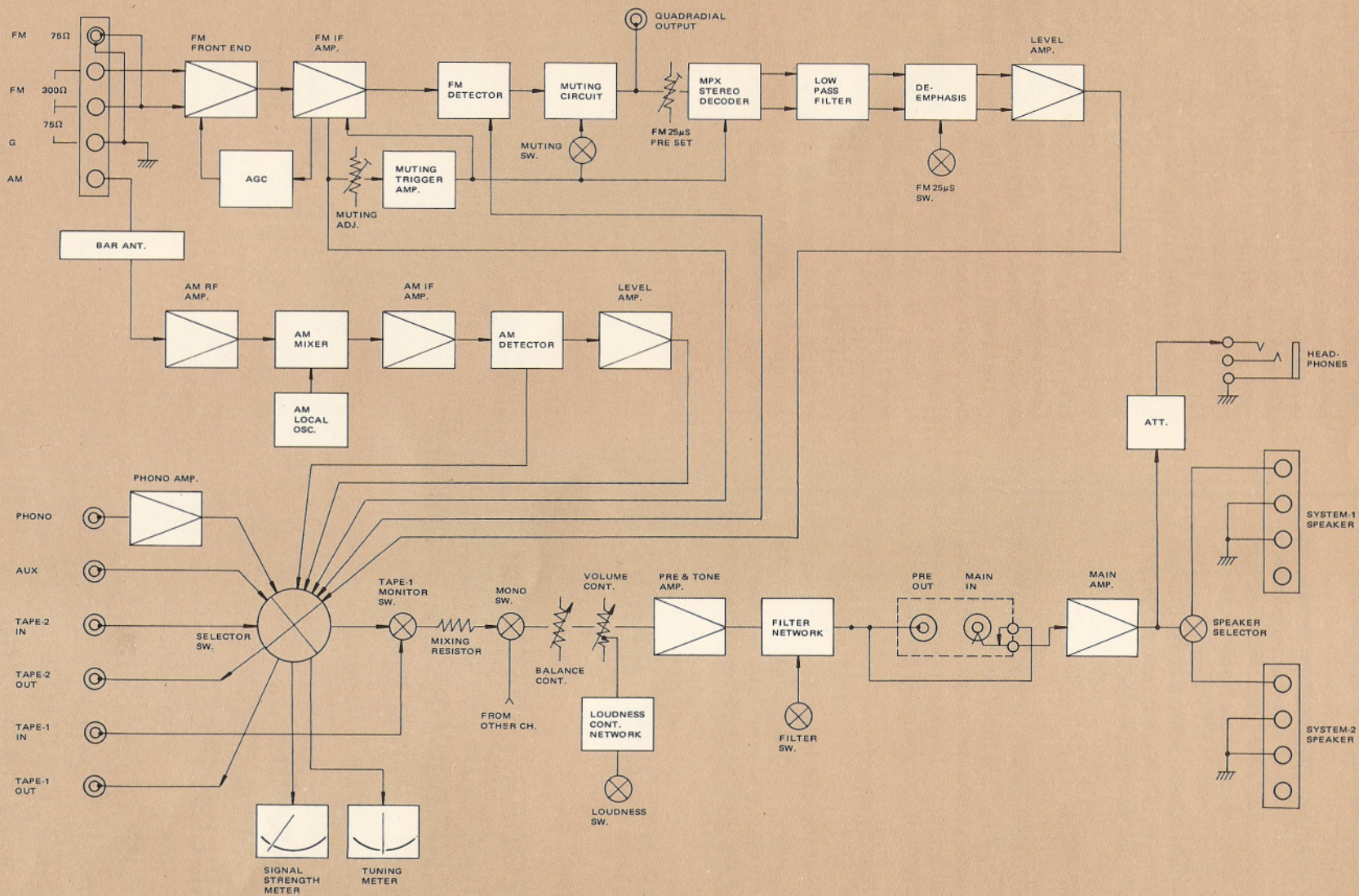

Figure 7. Functional Block Diagram

MAINTENANCE

CLEANING

The satin gold anodized finish of the knobs and heavy aluminum front panel will last indefinitely with proper care and cleaning. **NEVER** use scouring pads, steel wool, scouring powders, or harsh chemical agents, such as lye solution. These will mar the finish. Clean with a soft, lint-free cloth or cotton swab slightly dampened with a mild solution of detergent and water.

FUSE REPLACEMENT

The Model 2252 is protected by a 2 amp 250 V fuse. In the event the fuse blows out, replace it **ONLY** with a fuse of the same type and rating. Replacement with a fuse of higher rating will not protect the instrument and will void the warranty.

IN CASE OF DIFFICULTY

If the receiver and the dial lamps do not operate, make sure the power cord is connected. If the power cord is all right and your unit is equipped with an external AC line protector fuse, check the

fuse and replace it if necessary. If the dial lamps are properly illuminated but one channel is inoperative, check the loudspeaker cord of the inoperative channel for a short circuit, broken wire, loose connection or other fault. If the loudspeaker connections appear satisfactory, check for a broken, open, shorted, corroded, or disconnected shielded cable between the receiver and the input equipment. Check for improper setting of the **BALANCE** control. Look for any other visible fault. If no fault is noted, turn off the audio system, then transpose (left for right) the shielded source input cables at the receiver. If the opposite channel becomes inoperative when turned back on, then either the shielded cable or the input equipment is at fault. If the same channel remains inoperative, turn off power and similarly transpose the loudspeaker cords. If, when the system is turned on, there still is no sound from the same speaker system, then either the loudspeaker system or the loudspeaker cord is at fault. If the opposite speaker system fails to operate, then the receiver is inoperative. Refer the problem to your nearest authorized Marantz Service Facility.

SPECIFICATIONS GENERAL

Amplifier Section:

RATED POWER OUTPUT, MINIMUM CONTINUOUS AVERAGE POWER PER CHANNEL, BOTH CHANNELS DRIVEN	52 WATTS
POWER BAND	20 Hz to 20 kHz
TOTAL HARMONIC DISTORTION	0.1%
LOAD IMPEDANCE	8 OHMS
RATED POWER OUTPUT, MINIMUM CONTINUOUS AVERAGE POWER PER CHANNEL, BOTH CHANNELS DRIVEN INTO 4 OHM IMPEDANCE LOADS	65 W

I.M. Distortion

(I.H.F. method, 60 Hz and 7 kHz mixed 4 : 1 at rated power output)

at 8 ohm load impedance	0.1%
at 4 ohm load impedance	0.1%
Damping Factor (at 20 Hz)	45
Sensitivity (at MAIN IN)	1.5 V
Impedance (at MAIN IN)	30 k ohms
Frequency Response for Power Amp Only (at 1 Watt output, 20 Hz to 20 kHz)	±0.2 dB

Preamplifier Section:

Phono

Input Overload at 1 kHz	100 mV
Equivalent Input Noise	1.5 μV
Dynamic Range	96 dB
(Dynamic Range is the ratio of input overload to equivalent input noise)	
Input Sensitivity	1.8 mV
Input Impedance	47 k ohms
Frequency Response, RIAA 20 Hz to 20 kHz	±0.75 dB
Signal-to-Noise Ratio	76 dB
(at rated output and 7.75 mV input)	

High Level (Aux and Tape)

Input Sensitivity	180 mV
Input Impedance	85 k ohms
Frequency Response (includes power amp.)	10 Hz ~ 60 kHz ±1.25 dB
Signal-to-Noise Ratio	88 dB
(ref. to rated output and 775 mV input)	

Output Levels

Tape Out (ref. 7.75 mV at Phono inputs)	775 mV
Pre-Out (ref. 180 mV at Aux inputs)	1.5 V
(ref. 500 mV at Aux inputs, main amp. disconnected)	
Pre-Out	4.2 V

Output Impedance

Tape Out	600 ohms
Pre-Out	900 ohms

FM Tuner Section:

Sensitivity

IHF Usable	10.8 dBf (1.9 μV)
IHF 50 dB Quieting (mono)	17.3 dBf (4.0 μV)
(stereo)	37.2 dBf (40 μV)

Quieting Slope (Mono)

RF Input for 30 dB Quieting	9.8 dBf (1.7 μV)
Quieting at:	
20 dBf (5.5 μV)	51 dB
25 dBf (10 μV)	58 dB
40 dBf (55 μV)	65 dB
65 dBf (1000 μV)	72 dB

Quieting Slope (Stereo)

Quieting at:	
30 dBf (17 μV)	40 dB
40 dBf (55 μV)	50 dB
50 dBf (173 μV)	56 dB
65 dBf (1000 μV)	62 dB

Distortion (Mono) at 65 dBf (1000 μV)

100 Hz	0.25%
1000 Hz	0.15%
6000 Hz	0.4%

Distortion (Stereo) at 65 dBf (1000 μV)

100 Hz	0.35%
--------------	-------

1000 Hz	0.3%
6000 Hz	0.5%
Distortion (Mono and Stereo)	
at 50 dB Quieting, 1000 Hz	0.6%
Hum and Noise	
at 65 dBf (1000 μ V)	
Mono	-70 dB
Frequency Response	
30 Hz to 15 kHz	
Mono	+0.2, -2.0 dB
Stereo	\pm 2.0 dB
Capture Ratio	
at 45 dBf (100 μ V)	1.5 dB
at 65 dBf (1000 μ V)	1.0 dB
Alternate Channel Selectivity	70 dB
Spurious Response Rejection	90 dB
Image Response Rejection	70 dB
I.F. Rejection (Balanced)	95 dB
A.M. Suppression (1000 μ V)	50 dB
Stereo Separation	
100 Hz	42 dB
1000 Hz	45 dB
10 kHz	32 dB
Subcarrier Rejection	60 dB

AM Tuner Section:

IHF Usable Sensitivity	20 μ V
Distortion (THD), 30% Modulation	0.6%
Signal-to-Noise Ratio	49 dB
Frequency Response (\pm 3 dB)	40 Hz ~ 2.3 kHz
Alternate Channel Selectivity	46 dB
Image Rejection	45 dB
Spurious Response Rejection	50 dB
I.F. Rejection	40 dB

General:

Power Requirements	120 V AC, 60 Hz
Power Consumption at rated output, both channels operating	220 Watts
Idling Power (Volume Control at zero)	33 Watts

Dimensions:

Panel Width	440 mm (17-1/4")
Panel Height	137 mm (5-3/8")
Depth	365 mm (14-3/8")

Weight:

Unit alone	14 kg (30.8 lbs)
Packed for Shipment	17 kg (37.4 lbs)

SERVICE NOTES

REPAIRS

Only the most competent and qualified service technicians should be allowed to service the Model 2252. The Marantz Company and its factory-trained warranty station personnel have the knowledge and special equipment needed for repair and calibration of this precision instrument. In the event of difficulty, call the toll free telephone number listed on the back of the Warranty to obtain the name and address of the Marantz Authorized Service Station nearest your home or business. In many cases, the dealer where you purchased your Marantz unit will be equipped to provide service.

REPACKING FOR SHIPMENT

Should it become necessary to repack your Model 2252 for shipment to the factory, to an authorized service station, or elsewhere, please observe the following precautions:

- a. Do not ship the unit installed in its accessory walnut cabinet; remove the unit from the cabinet before packing.
- b. Pack the unit carefully, using the original material as shown in Figure 8.
PLEASE NOTE that if you have discarded, lost, or damaged the packing material, new packing material may be obtained by writing to the Marantz Technical Service Department. The carton, its fillers, and packing instructions will be returned to you at a nominal charge.
- c. Ship via a reputable carrier (do not use Parcel Post) and obtain a shipping receipt from the carrier.
- d. Insure the unit for its full value.
- e. Be sure to include your return address on the shipping label.

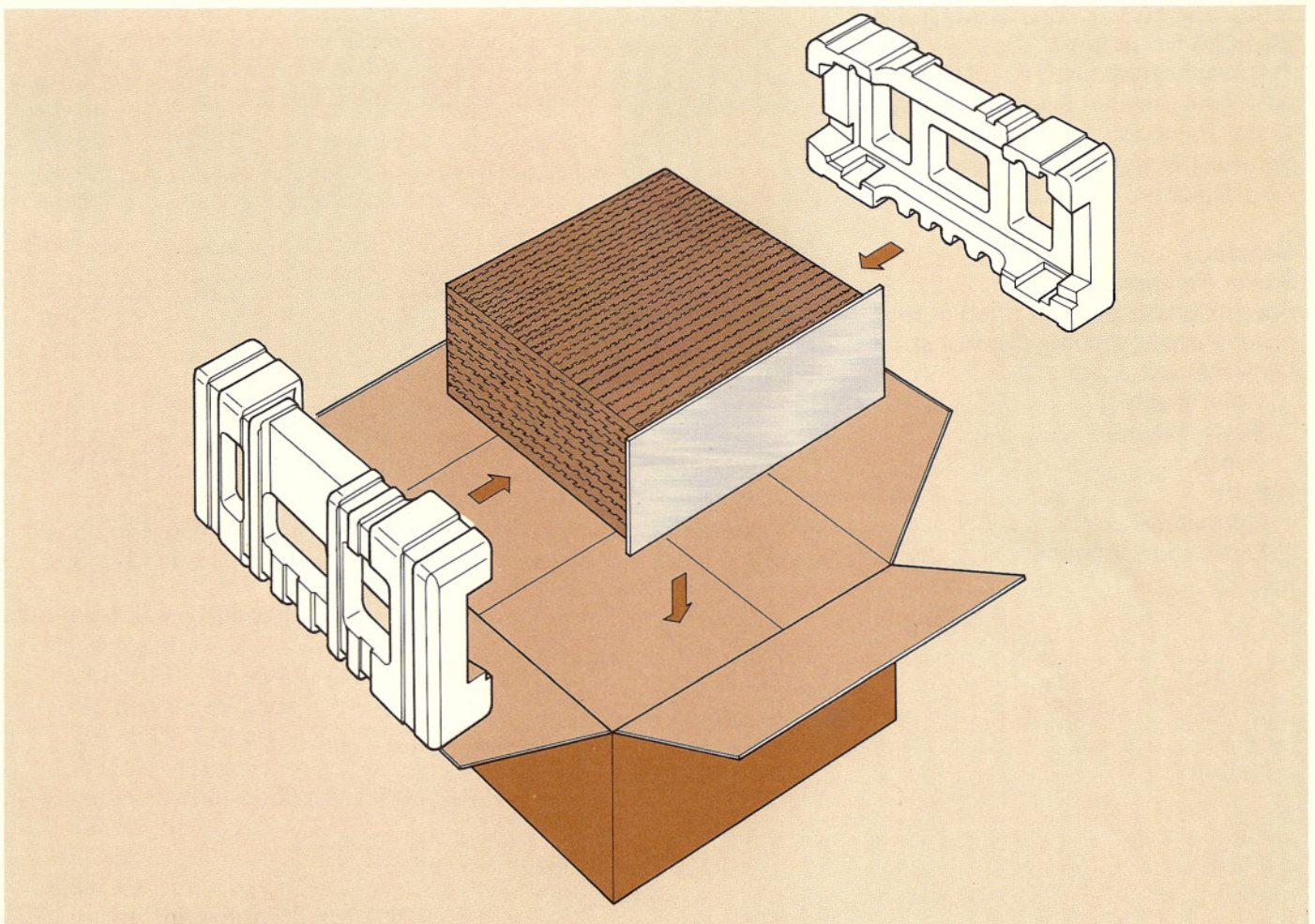

Figure 8. Packing Instructions

The Sound of Marantz
is the compelling warmth of a Stradivarius.
It is a dancing flute, a haughty bassoon
and the plaintive call of a lone French horn.
The Sound of Marantz is the sound of beauty,
and Marantz equipment is designed to bring you
the subtle joy of its delight.
Wonderful adventures in sound await you
when you discover that the Sound of Marantz
is the sound of music at its very best.



marantz.